



Time Electronics
Calibration, Test and Measurement

User Manual

8100 Instrumentation Test Stand

Version 1.1
March 2021

Time Electronics Ltd

Unit 5, TON Business Park, 2-8 Morley Road,
Tonbridge, Kent, TN9 1RA, United Kingdom.

T: +44 (0) 1732 355993 | F: +44 (0) 1732 350198
mail@timeelectronics.co.uk | www.timeelectronics.com

© 2021 Time Electronics Ltd.

All rights reserved.

Nothing from this manual may be multiplied, or made public in any form or manner, either electronically or hard copy, without prior written consent from Time Electronics Ltd.

This also applies to any schematics, drawings and diagrams contained herein.

This manual provides operating and safety instructions for the Time Electronics product.

To ensure correct operation and safety, please follow the instructions in this manual.

Time Electronics reserves the right to change the contents, specifications and other information contained in this manual without notice.

Contents

1	Introduction.....	4
1.1	Features	4
1.2	Description.....	5
2	Setup.....	6
2.1	Unpacking and Positioning	6
2.2	Example worktop positioning	7
3	8100 Parts.....	8
3.1	Assembled Parts Image	8
3.2	Parts List.....	9
3.3	Non-Slip Mat	10
3.4	Base Plate	10
3.5	Manifold	12
3.6	Upright Support	14
3.7	Support Clamp.....	17
3.8	Angle Bracket	18
3.9	Multi-Hole Bracket	20
3.10	Compression Quick Vice	23
3.11	Retort Rod	25
3.12	Tools and Extras.....	26
4	Example Configurations	27
4.1	Vertical Pole Mounted Configurations	27
4.2	Horizontal Pole Mounted Configuration	30
4.3	Support Clamp Configurations.....	31
5	Warranty and Servicing.....	36

1 Introduction



1.1 Features

- Multi-purpose test stand for process instrumentation
- Configurable solution with track base on rubber mat
- Transmitter fixing poles for U-bolt connections
- Vertical and horizontal pole positioning, height adjustable
- Pressure manifold with hand-tight quick connection
- Quick-vice with sliding jaw and one handed lever arm
- Upright support with clamp mechanism
- Easy to configure as per user requirements
- Clamping section can be used for direct mounting of UUTs or angle bracket
- Tools include electric screwdriver, bit set 3 adjustable spanners, hex key set cable ties
- Additional fixtures and fittings for customised mounting setups
- Retort rod with 3 prong clamp for holding temperature sensors, RTDs, thermocouples

1.2 Description

The 8100 is a multi-purpose test stand, primarily for use with process instrumentation in the workshop or lab.

It is a compact workstation that provides users with quick and customisable setups for common testing applications and service work. These include practical mounting of various pressure transmitters and gauges, temperature transmitters, RTDs and thermocouples.

A solid aluminium base plate situates on a non-slip rubber mat, providing a sturdy base for working with heavy transmitters and other devices. The base allows the fixtures and tools to be easily connected, with knurled knob thumb screws and clamps to secure them in place. The fixtures can slide back and forth along the tracks for an optimal working position. They can also be removed and repositioned as per user preference.

An upright support with clamp mechanism can be used to hold poles (2 supplied) either vertically or horizontally, for u-bolt transmitter mounting. The clamp mechanism features a front and rear section for this purpose (rear: vertical, front: horizontal). These clamp sections have step jaws that are tightened with cylinder bolts.

An electric screwdriver is supplied to speed up the setup process. The clamp jaws are also utilised for direct mounting of instrumentation, or for holding angle brackets that connect to transmitters.

A compact single port pressure manifold connects to the base track with a clamp fitting to enable positioning as required. It features a hand-tight connector for the UUT side.

A dual port version is optional. Models for pneumatic and hydraulic work are also available.

The 8100 is supplied as a comprehensive kit with tools and fixtures for a variety of tasks. Tools include 3 adjustable spanners, electric screwdriver, bit set, folding triangle hex key set, and cable tie set. Additional fixtures are provided to connect to the base plate and the upright clamp sections.

2 Setup

2.1 Unpacking and Positioning

The 8100 is supplied assembled for easy installation and positioning.

Initial setup steps:

1. Remove the rubber mat from the packing.
2. Unroll the mat and place on the worktop where you want to use the 8100.
If you are working on a CalBench then place the mat on the left side of the worktop near the pressure modules.
3. Remove the 8100 base plate (attachments will be pre-fitted) and place on the mat.

Shown below is a common location for the 8100 to be positioned on the CalBench system. It positions to the left side at the front for the worktop.

This allows users to connect hoses from pressure modules to the manifold or instrumentation mounted on the 8100.

When being used with transmitters the 8100 can be move more centrally to enable the electrical connections to the 8060 process calibrator module (or 7051 if fitted).



2.2 Example worktop positioning

Example of 8100 being used on the CalBench, with the 8030B pressure controller module.

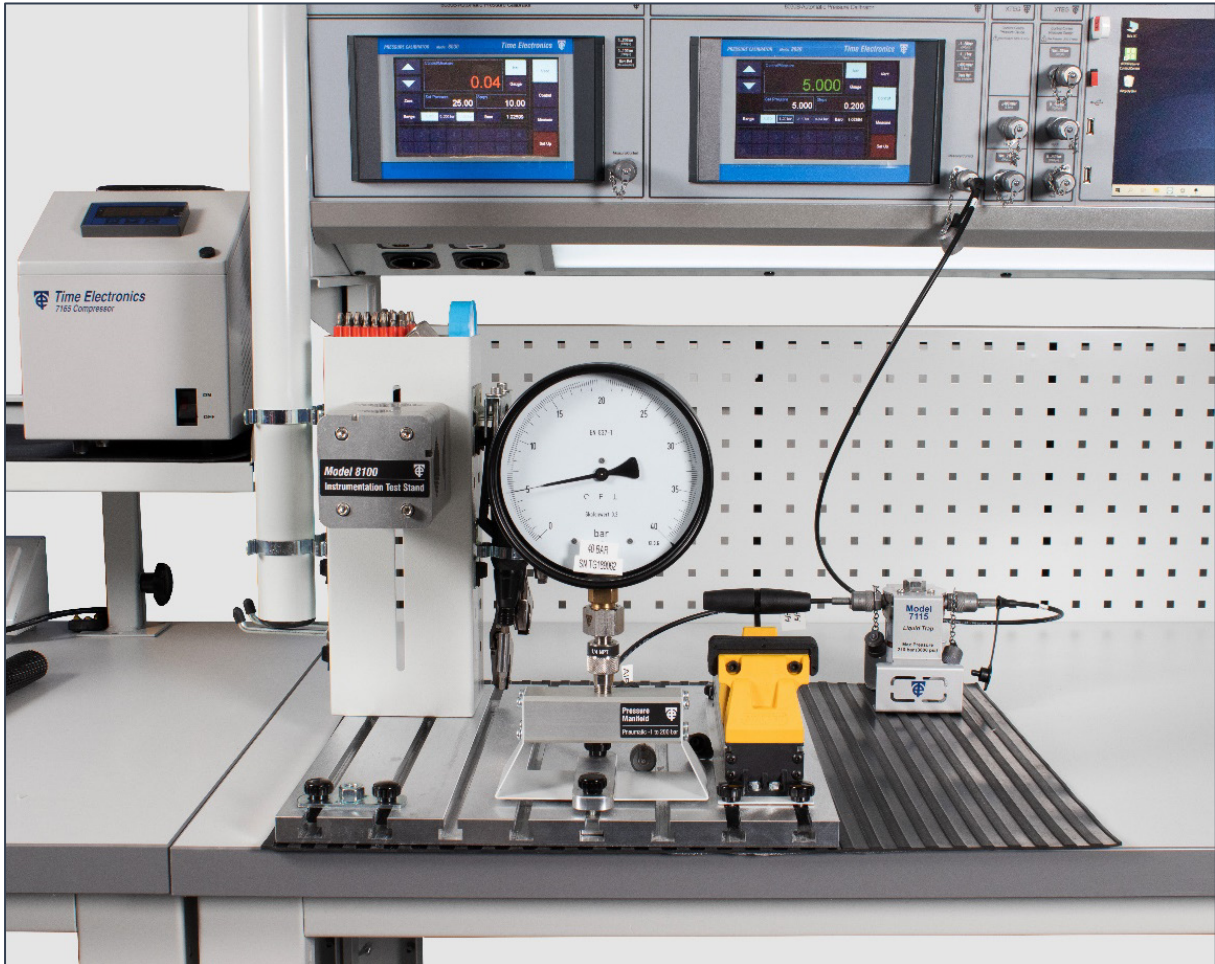

The 8030B is connected to the 7115 contamination trap (supplied separately), then to the 8100 manifold with the analogue gauge being tested.

3 8100 Parts

3.1 Assembled Parts Image

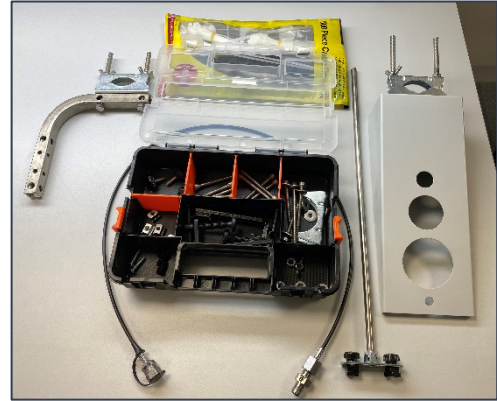

Additional Items:
Retort rod / Angle bracket / Multi-hole bracket
Spares case / Pressure hose / Cable tie set

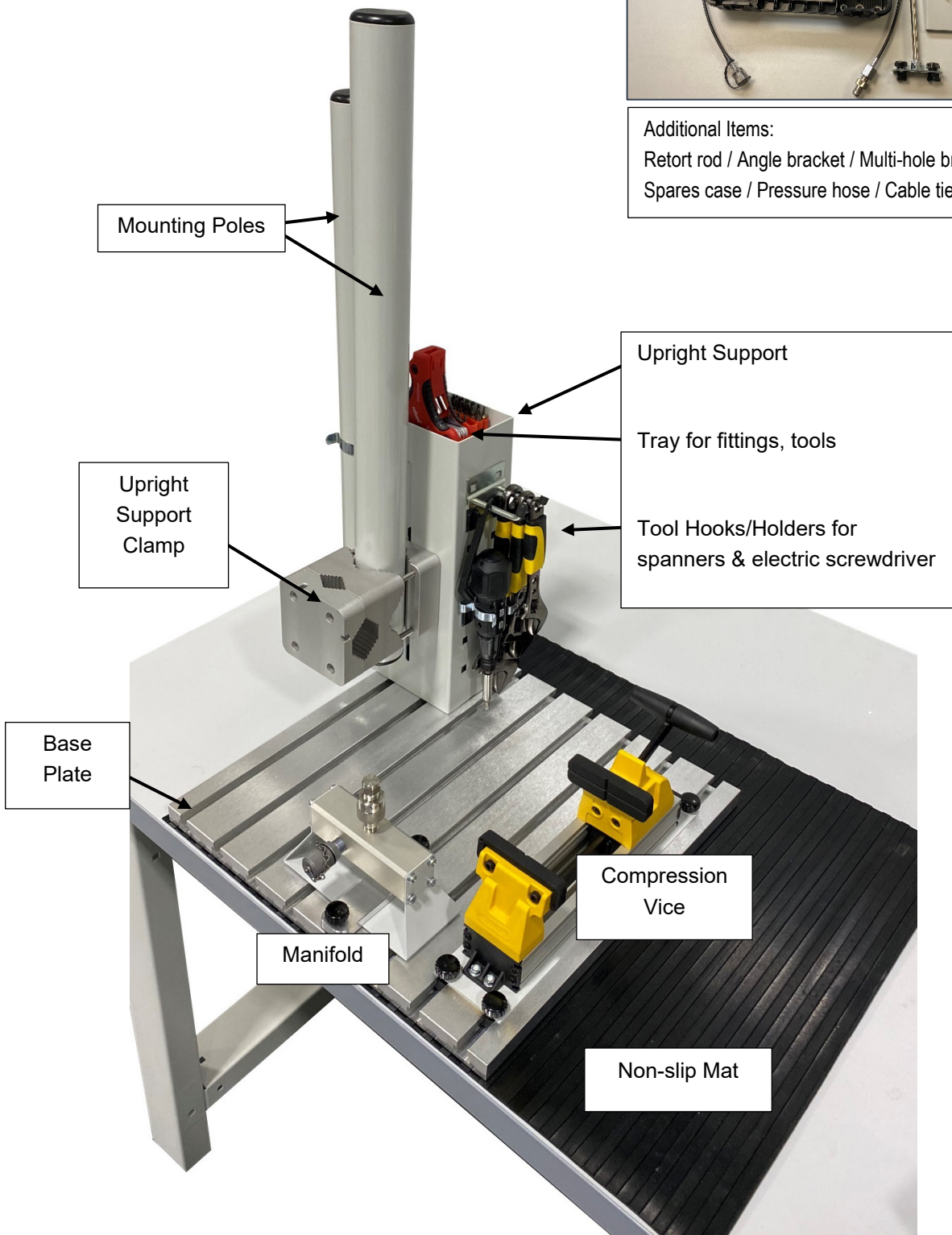

3.2 Parts List

Part	Details/Specification
Non-slip mat	600 x 500 mm, wide ribbed. To be placed under base.
Base plate	400 x 400 mm aluminium t-slot plate. Connection to base via knurled thumb screws and clamps, into T-slot nuts.
Upright support	Connects to base plate, features fittings tray, perforated sides with pre-fitted holders for pole storage and tool hanging. Slotted front section for support clamp fitting.
Support clamp	Connects to upright with height adjustment in slotted section. Features 2 section clamping with step jaws. 60 mm cylinder bolts close the clamps when holding poles, brackets and UUTs.
Mounting Poles	2 supplied, Ø 50 mm
Single port manifold	Suitable for pneumatic vacuum to 200 bar. Hand-tight connector for UUT - 8100: 1/4 BSP. 8100-NPT: 1/4" NPT. Input connection: minimess (hose supplied).
Compression Quick vice	Fast close mechanism, quick fit and trigger action. Soft jaws with rubber pads. Clamping force: 180kg. Clamping capacity: 110mm. Table mounting brackets supplied for use off the base plate.
Retort rod	H500 mm, Ø 10 mm, with boss head connection and 3 prong clamp with rubber jaws. Connects to base plate via a M10 threaded nut adaptor.
Angle bracket	Transmitter bracket with pole bracket. Pole or Support Clamp mounting possible.
Multi-hole bracket	Mountable platform with holes for transmitter, thermocouples etc. Pole or Support Clamp mounting possible.
Tools	3 adjustable spanners (150, 200 and 250 mm), electric screwdriver, 33 pc bit set, 9 pc folding triangle hex key set, and cable tie set.
Spares/Extras	Supplied in assortment storage case with dividers: 4 x 60 mm cylinder bolts (spares for bolts used in support clamp) 4 x 70 mm cylinder bolts (used for making support clamp wider) 4 x 100 mm cylinder bolts (used for making support clamp wider or UUT mounting on bolts). M6 washers supplied. Used with u-bolt clamp. 1 x pressure hose for use with manifold: 8100: Minimess to 1/4 BSP female / 8100-NPT: Minimess to 1/4" NPT female 1 x pressure adaptor for use with pressure hose: 8100: 1/4 BSP male to 1/4 BSP male / 8100-NPT: 1/4" NPT male to 1/4" NPT male 2 x M6 T-slot nuts, 2 x M8 T-slot nuts. 2 x M6 thumb knob screws 15 mm. 2 x M6 thumb knob screws 20 mm. 1 x u-bolt clamp for use with bolts (see clamp bolt mountings setup). 2 x M8 wing nuts, 2 x M8 nuts, 4 x M8 washers.

3.3 Non-Slip Mat

A 600 x 500 mm wide non-slip ribbed rubber mat is supplied to place underneath the base. This ensures no movement of base plate and helps to protect the worktop. It is sized to provide an area to put tools or items next to the base plate.

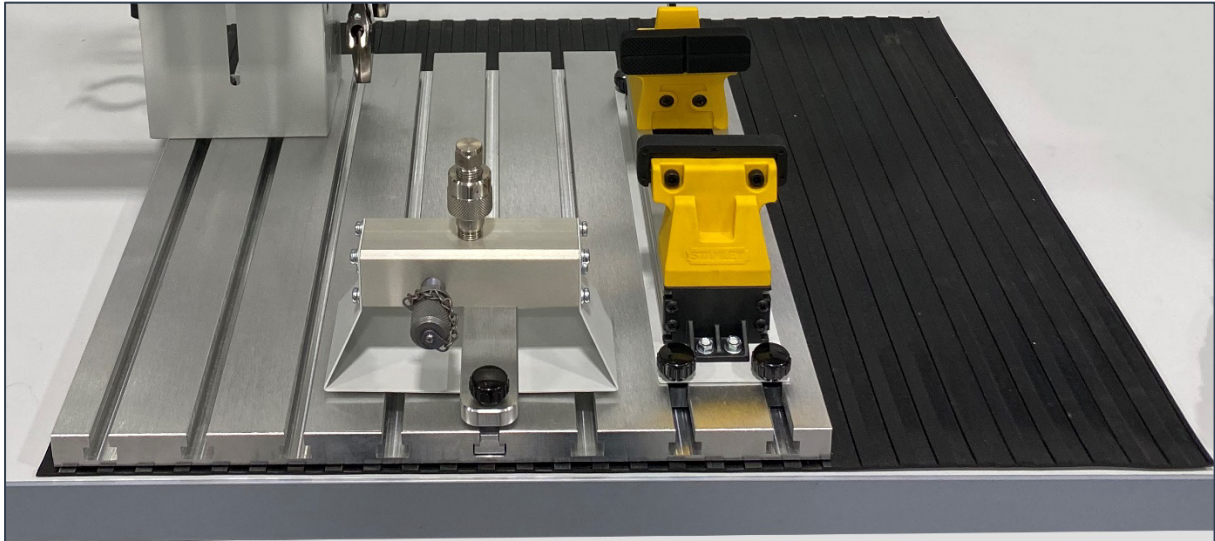

3.4 Base Plate

The base is a 400 x 400 mm cast aluminium t-slot plate. It is 9 kg and provides a strong and stable foundation for the mounting of heavy instrumentation.

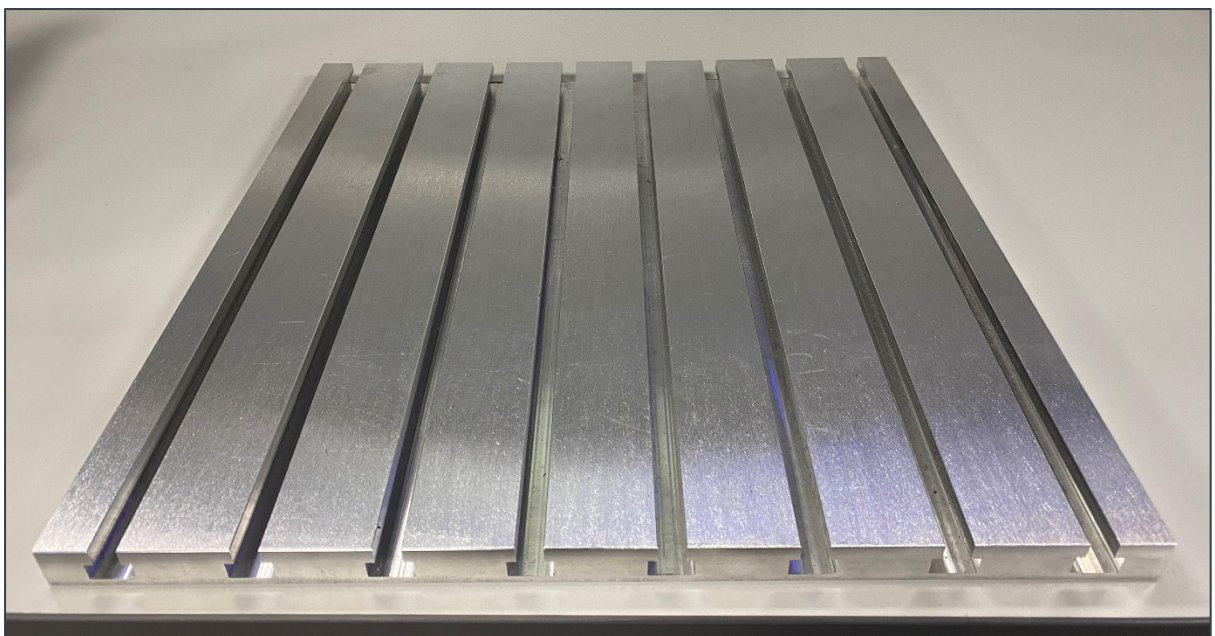

The t-slot tracks are used to fix the various items to the base. T-nuts slide into the tracks and the fixtures screw into them. The manifold uses a special T-bar and clamp plate.

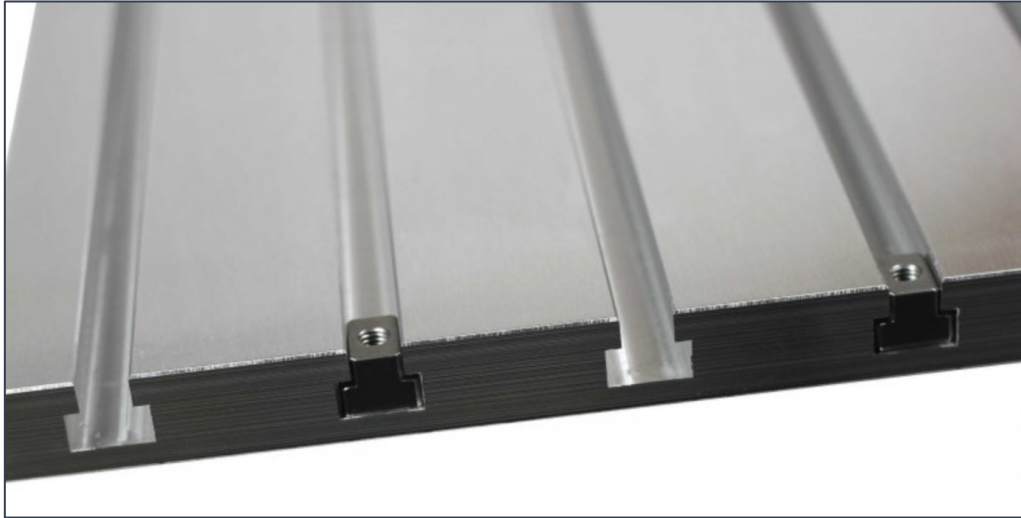

The 8100 is supplied ready for use, as per the below configuration. This layout enables users to access the attachments and move them backwards or forwards along the tracks.



3.5 Manifold

The 8100 features a single port manifold as standard. It fixes to the base using a T-bar and clamping plate. 2 hand-tightened knobs secure the manifold in position. This fixing means that the manifold is stable and can be used with transmitters or large gauges without toppling over.

The outlet port on the top is a hand-tight fitting, either ¼ BSP or ¼" NPT thread. Other threads are available upon request. The inlet port is minimess type with hose supplied.

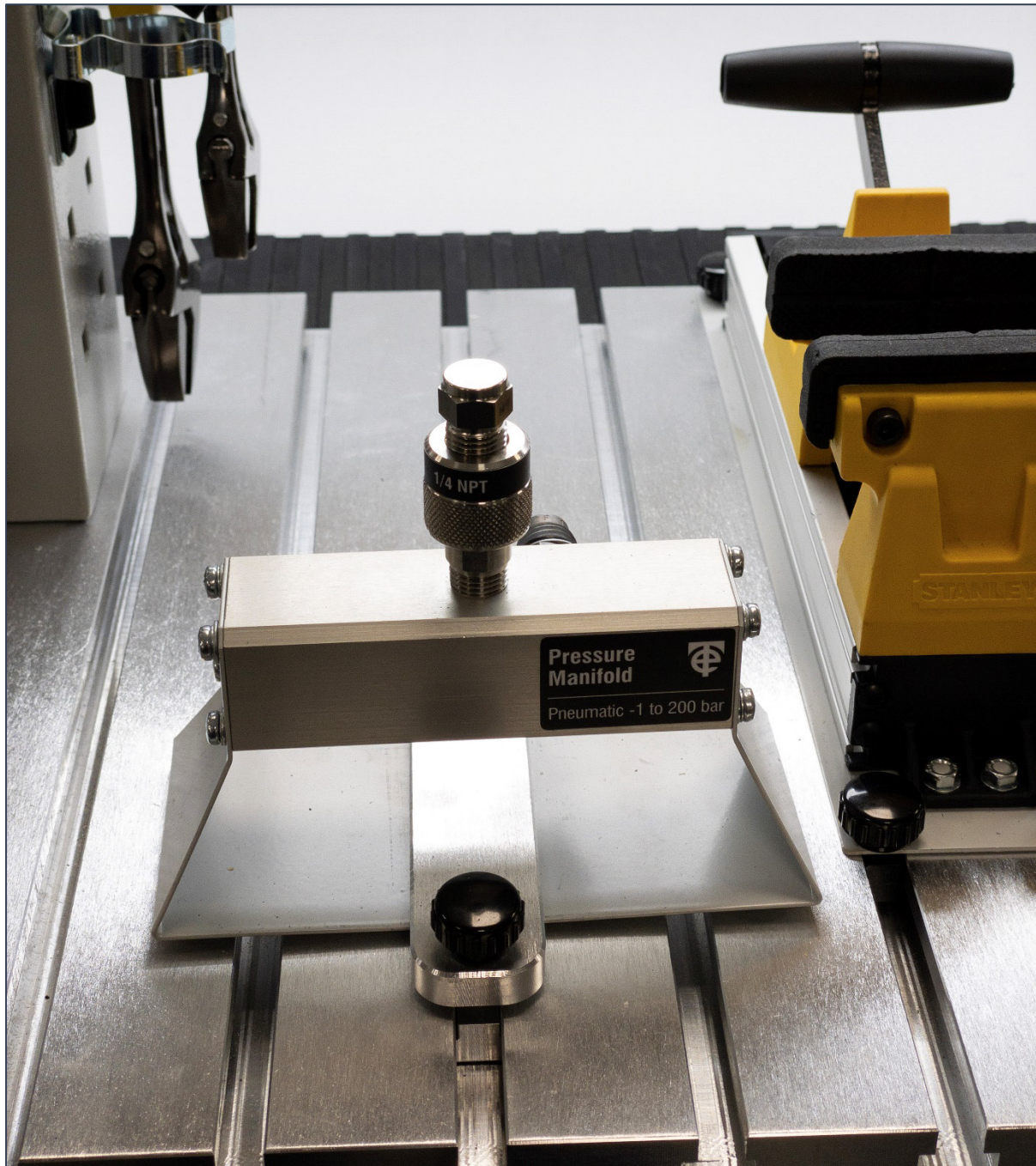

The manifold can be moved by loosening the knobs and gently lifting upwards and along the tracks. This is useful if you want to re-position the manifold to the rear of the base during repair work.

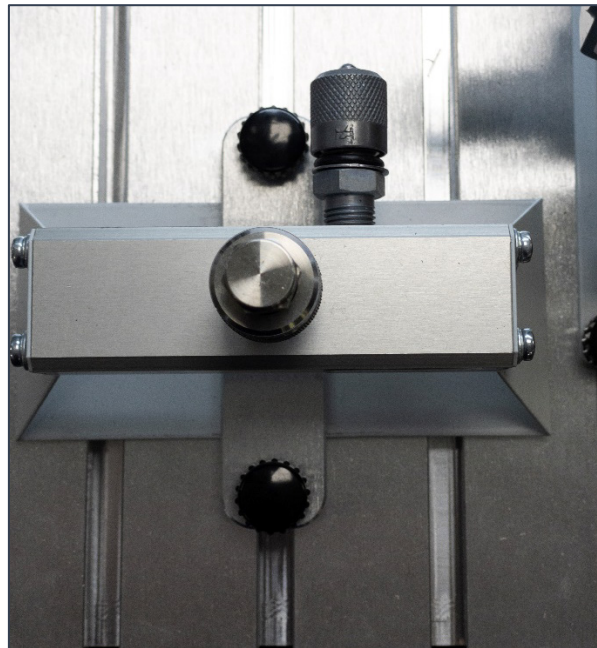

Note that the clamping plate features a raised under section to clamp the base of the manifold.



The manifold is rated for use up to 200 bar pneumatic.

A version is also available for hydraulic use up to 700 bar. All manifolds can be removed and used stand alone. They have padded feet for use on the worktop.

A 2-port manifold is available as an option. When ordered with the 8100 it comes with 2x clamp bars/plates for base connection.

Model 7161 shown here.

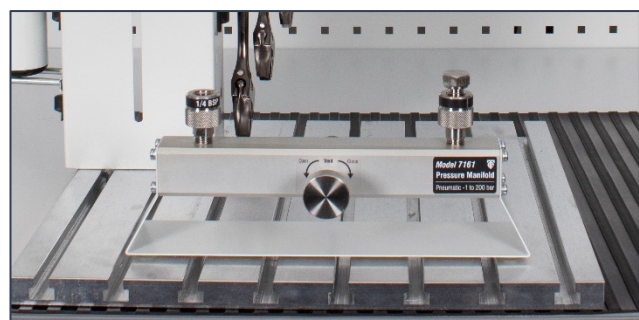

3.6 Upright Support

The upright support is a rectangular steel section that connects to the base plate and is then fitted with the support clamp in the front slot. The upright support also has sections for storage and placement of tools and parts.

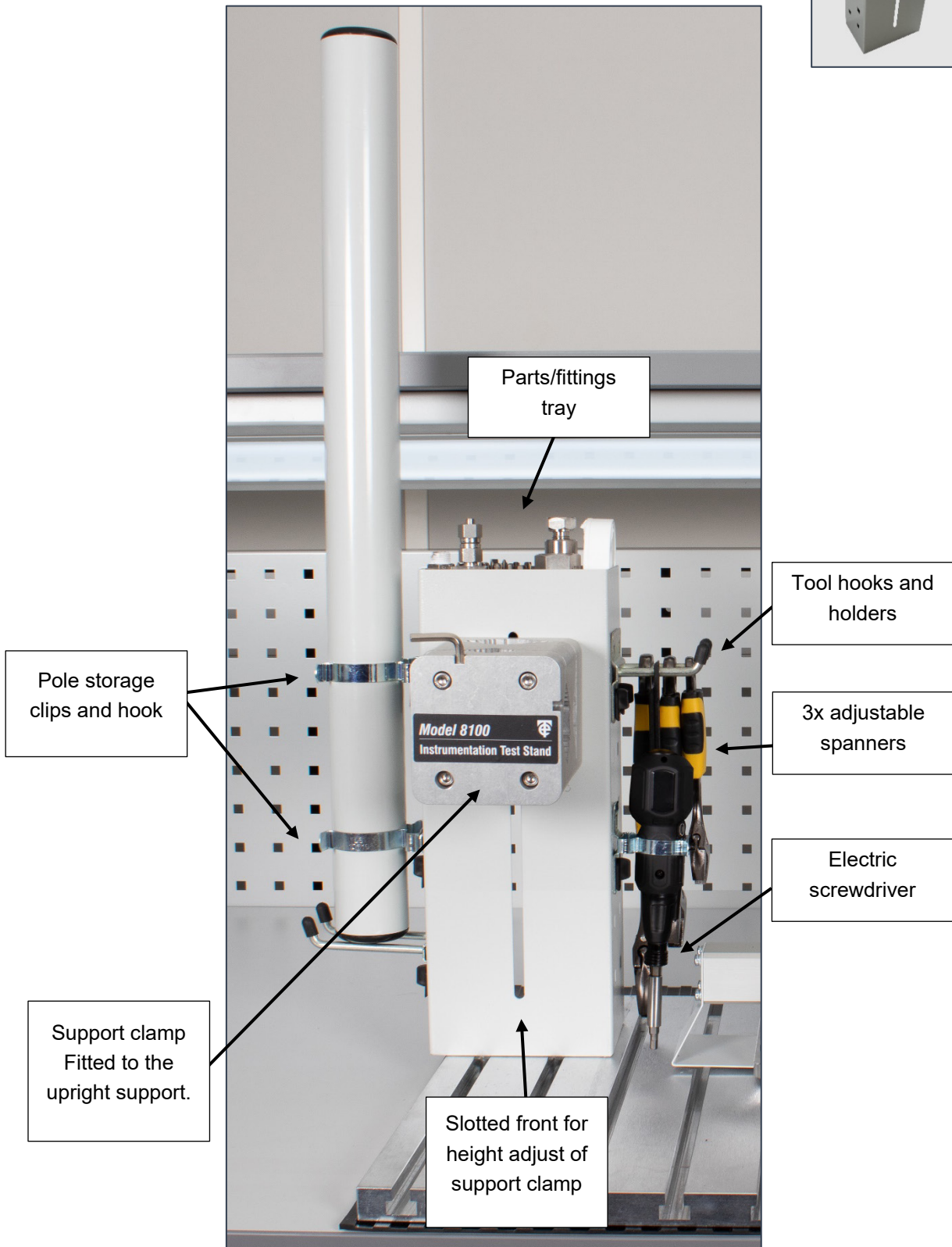
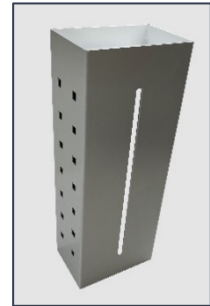

The back of the upright support is open to enable access to the adjustment knobs.

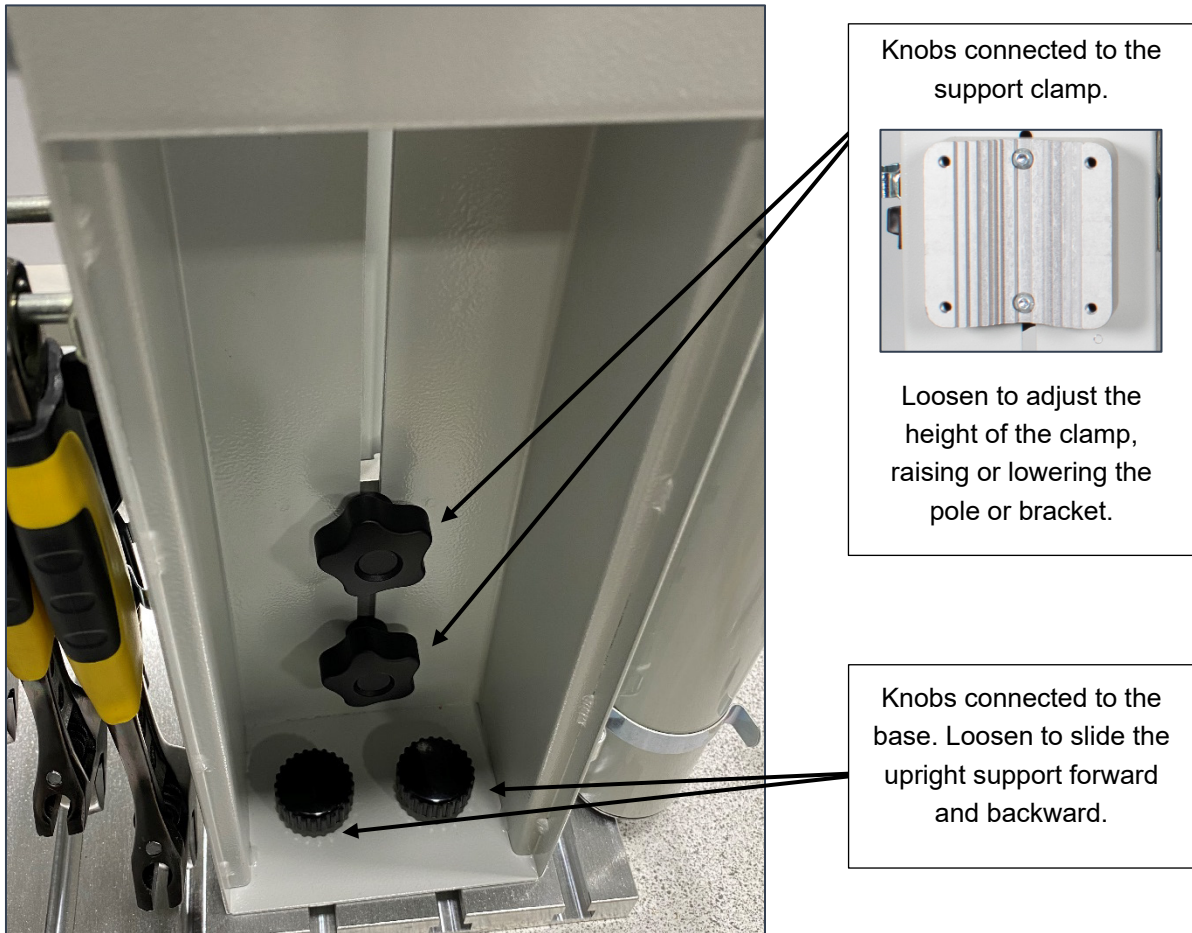

You can also re-position the upright support by removing the base knob screws and using the T-slot nuts in another location on the base plate.

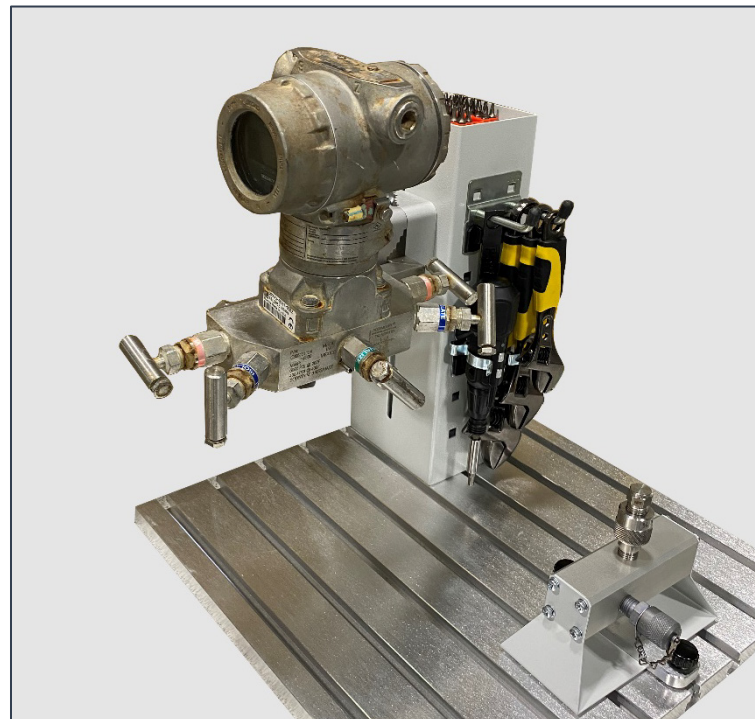

The top tray can be used for fittings, parts and tools storage.

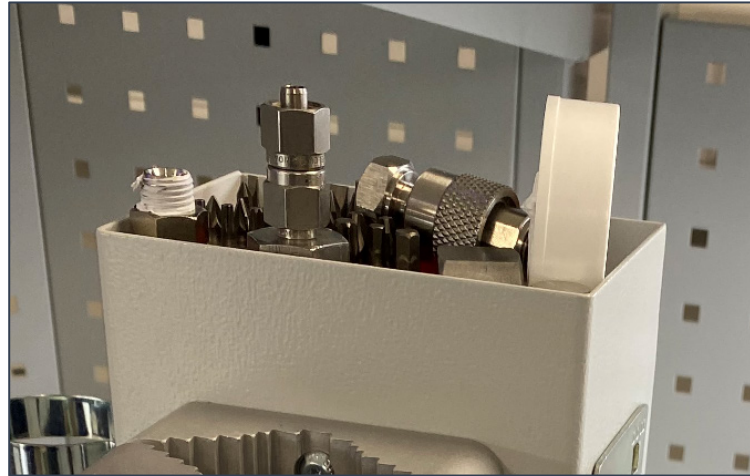

The sides of the upright support are perforated for tool hook/holder mountings.

The right side is pre-fitted with a double hook that holds the 3 adjustable spanners.

The electric screwdriver fits to a clip for easy removal when needed.

A perforated fitting tool is supplied to enable users to change or remove the perforated fittings.

The left side of the upright support features 2 clips and a double hook. This is for locating the pole when not in use. To insert the pole press the base into the hook at an angle, and then push the pole into the clips.

WARNING:

Do not mount anything onto the pole when it is clipped for storage.

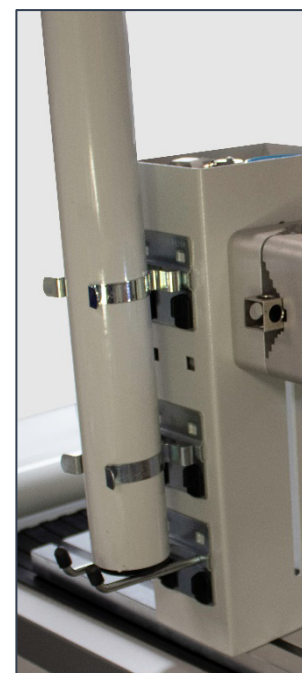
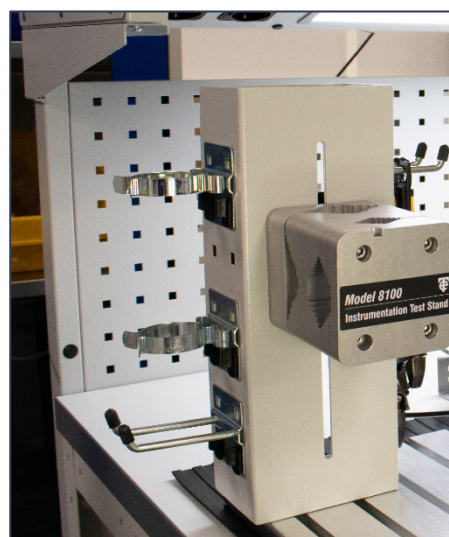

3.7 Support Clamp

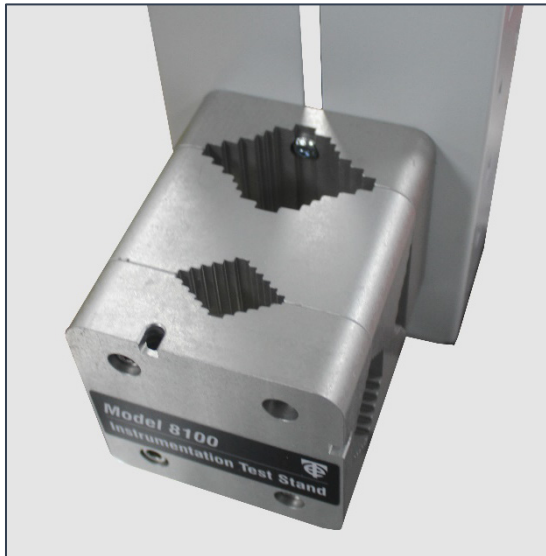

The support clamp is used to hold the poles and brackets.

It can be moved up or down from the back, as shown in the Upright Support chapter.

The clamp is made up of 3 pieces that join together to provide 2 clamping sections.

They are joined together with 8 x M6 cylinder bolts.

The bolts fitted as standard are 60 mm long. Spare bolts of 70 and 100 mm are also supplied to enable wider clamping to be performed.

4 x cylinder bolts attach the middle to the back, forming the first part of the clamp that is used to hold vertical poles and angle brackets.

The electric screwdriver comes with the hex bit to enable the cylinder bolts to be tightened, loosened, or removed as needed.

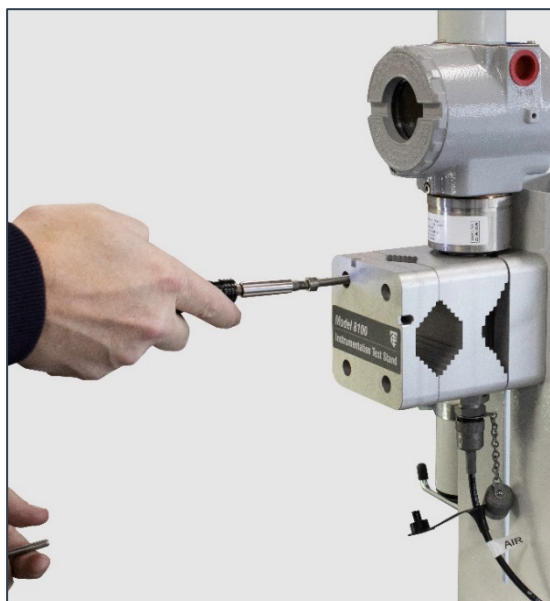
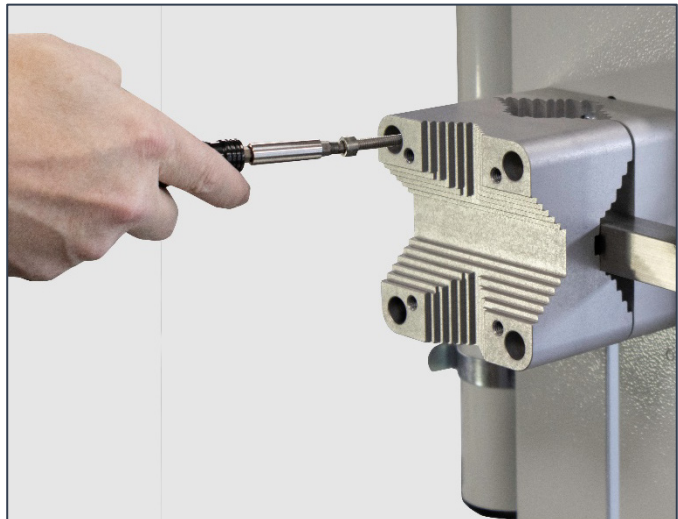

The front piece is attached in the same way, with 4 x cylinder bolts.

The front clamp is for horizontal poles.

Both the front and rear clamp sections can be used to place and hold various instrumentation and parts.

3.8 Angle Bracket

The angle bracket is supplied with u-bolt clamps fitted, for pole mounting.

Place the clamp over the pole and tighten with the wing nuts. Use the spanner to hold the bolt heads if needed.



The angle bracket can also be used with the support clamp. Remove the u-bolt clamps and place the bracket in the support clamp. Tighten with the electric screwdriver.

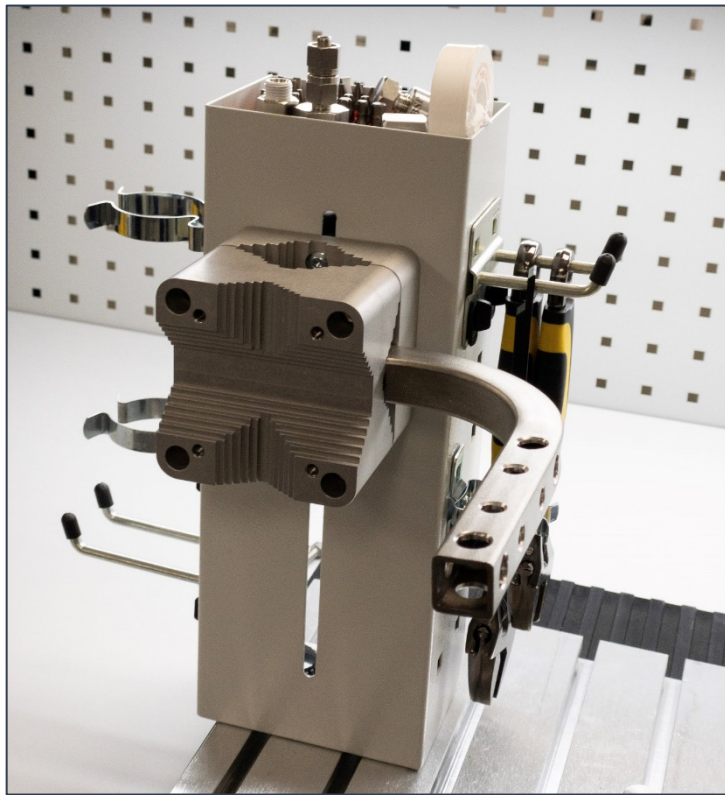

The bracket clamps in the rear jaws as shown.

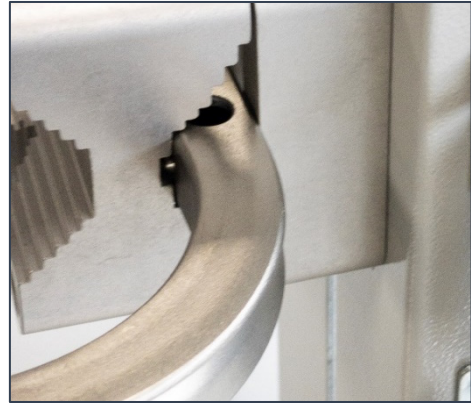

Use the electric screwdriver to tighten the support clamp.

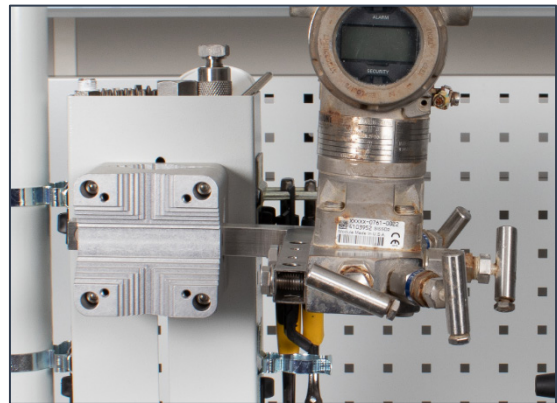
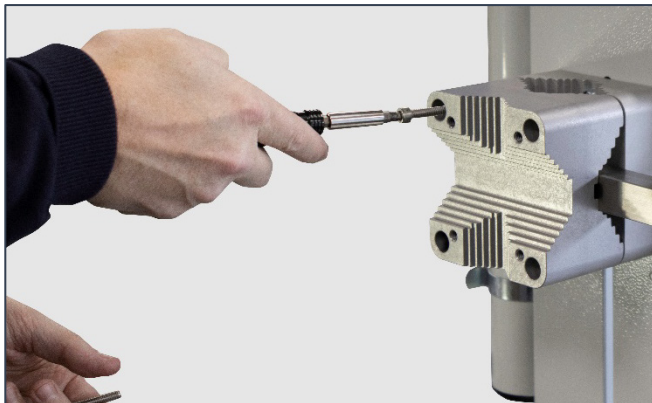

Another mounting for the angle bracket is to utilise the 100 mm cylinder bolts (supplied as spares) that go into the support clamp.

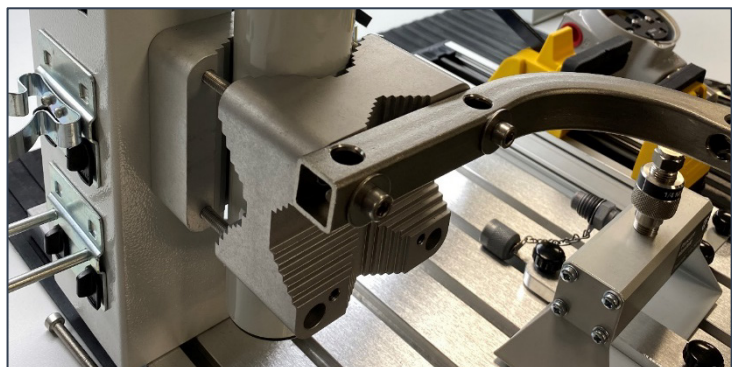

3.9 Multi-Hole Bracket

This bracket comes fitted with the pole mounting clamps.

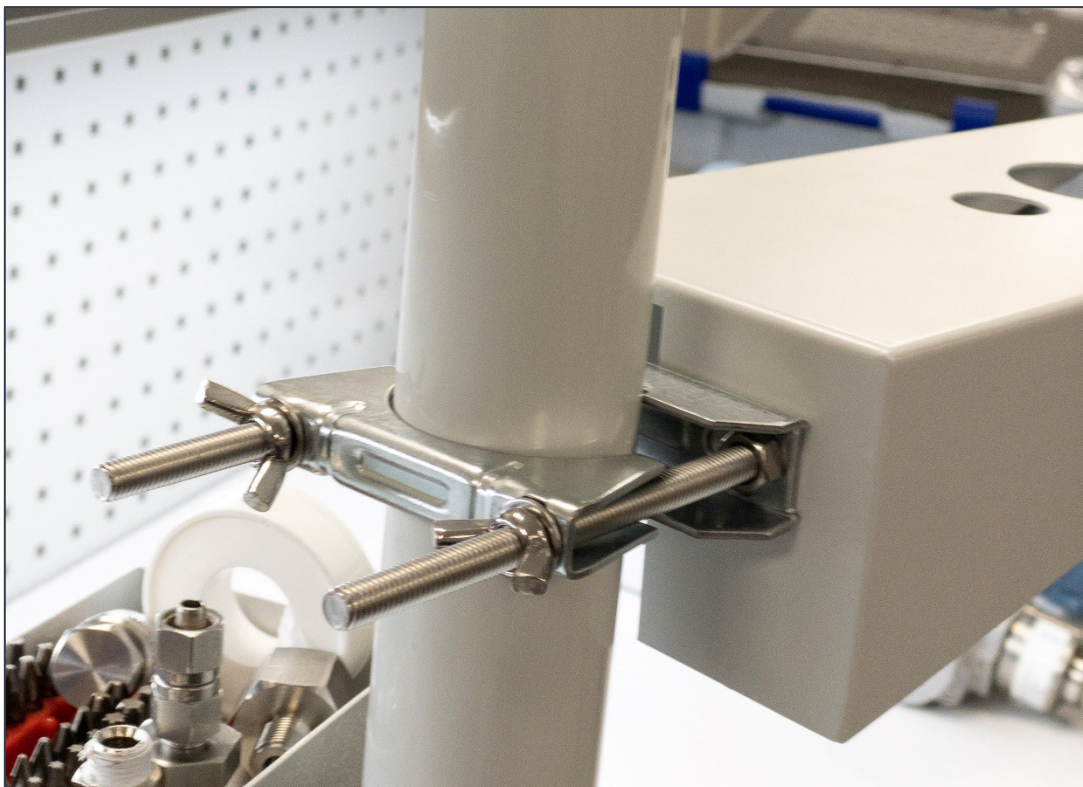

The multi-hole bracket can also be used on the support clamp.



To do this, unscrew and remove the pole clamps.

The rear of the multi-hole bracket has a slot in the centre.



On the support clamp, loosen the knobs on the rear by reaching around to the inner section of the upright support. The clamp will lower to the bottom. The slotted back of the multi-hole bracket then slides down to fit the gap and secure in place.

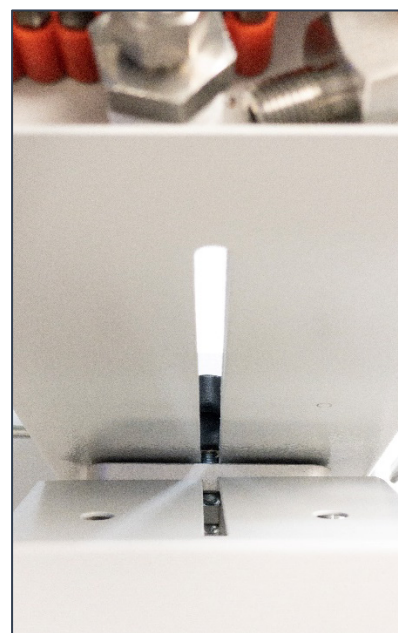
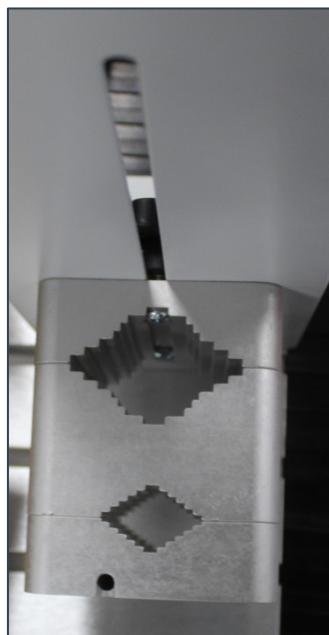

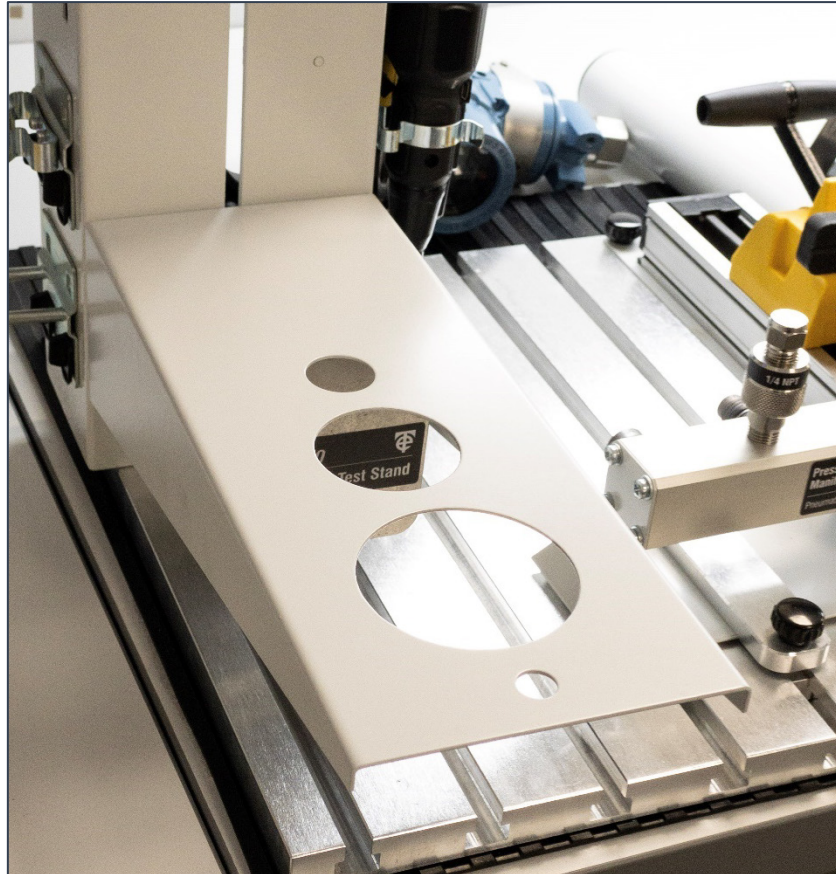

3.10 Compression Quick Vice

The vice is a useful tool that provides a fast and easy way to hold instrumentation and/or their related fittings and parts. It is supplied fitted to the base plate as shown.



It can be re-positioned by loosening the thumb screws and sliding into the tracks.

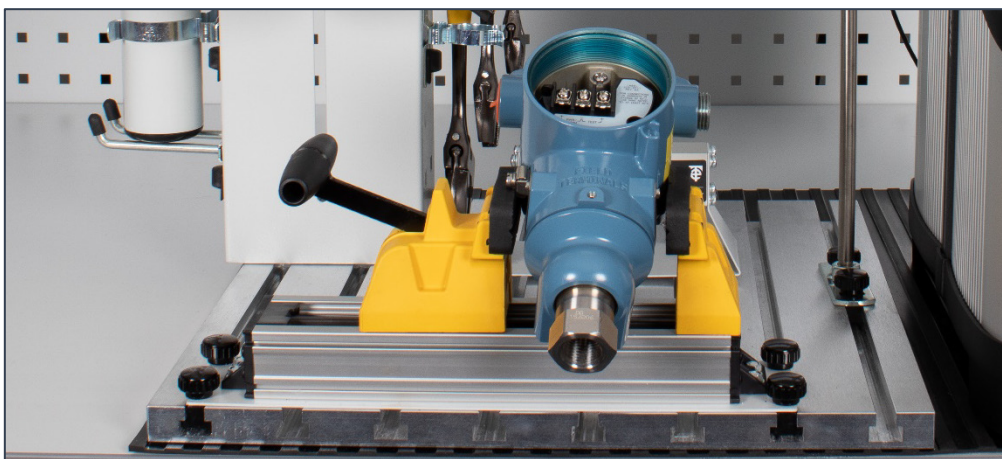

The vice can also be removed from the base and used on a worktop independently.

brackets are supplied to enable it to clamp to a work surface as shown



Vice Features

- One handed lever arm - Quick to open and close vise
- Quick repositioning of vise - Jaw slide open and close quickly
- Removable rubber pads with steel jaw underneath
- Steel construction - For durability and long life

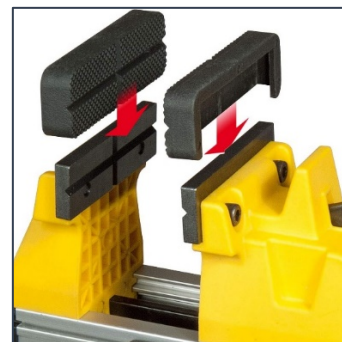
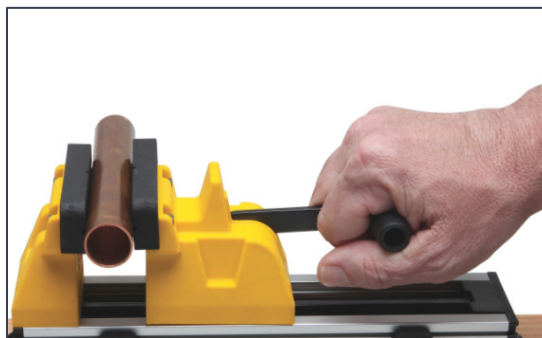

3.11 Retort Rod

The retort rod comes with the mounting plate that connects to the base.

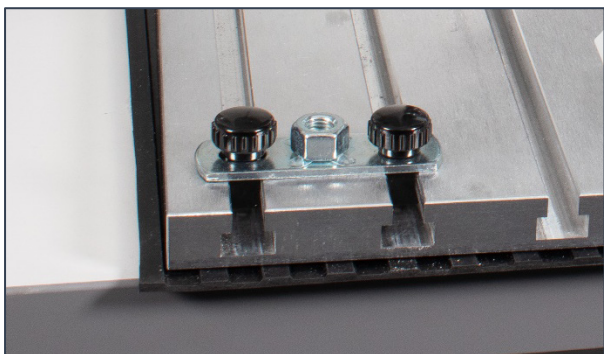

3.12 Tools and Extras

The 8100 is supplied as a kit with a selection of tools and extras for use with the test stand, and in the workshop.



The **electric screwdriver** is a useful tool and speeds up the screwing and unscrewing of the cylinder bolts on the support clamp. It is also a practical solution for various other tasks.

The **adjustable spanners** are a common requirement when working with instrumentation. The three supplied (150, 200, 250 mm) are used on the test stand to remove parts like pressure fittings and adaptors.

A **9 piece folding triangle hex key** are supplied for manual adjustment of the cylinder bolts if the electric screwdriver is not available.

Spare parts are included in a storage case:

- Cylinder bolts: 4 x 60 mm. 4 x 70 mm. 4 x 100 mm.
- 2 x M6 T-slot nuts, 2 x M8 T-slot nuts.
- 2 x M6 thumb knob screws 15 mm.
- 2 x M6 thumb knob screws 20 mm.
- 1 x u-bolt clamp for use with bolts (see clamp bolt mountings setup)
- 2 x M8 wing nuts, 2 x M8 nuts, 4 x M8 washers



4 Example Configurations

4.1 Vertical Pole Mounted Configurations

4.1.1 Basic Setup

The pole mounts in the rear section of the upright support clamp.

It is height adjustable, ready for use with u-bolt mounted transmitters.



4.1.2 Pole Mounted Angle Bracket

The angle bracket clamps to the vertical pole.



4.1.3 Pole Mounted Multi-Hole Bracket



4.2 Horizontal Pole Mounted Configuration

The pole is clamped horizontally for use with u-bolt clamps or horizontal mounting brackets. The pole is held into the front section of the support clamp.

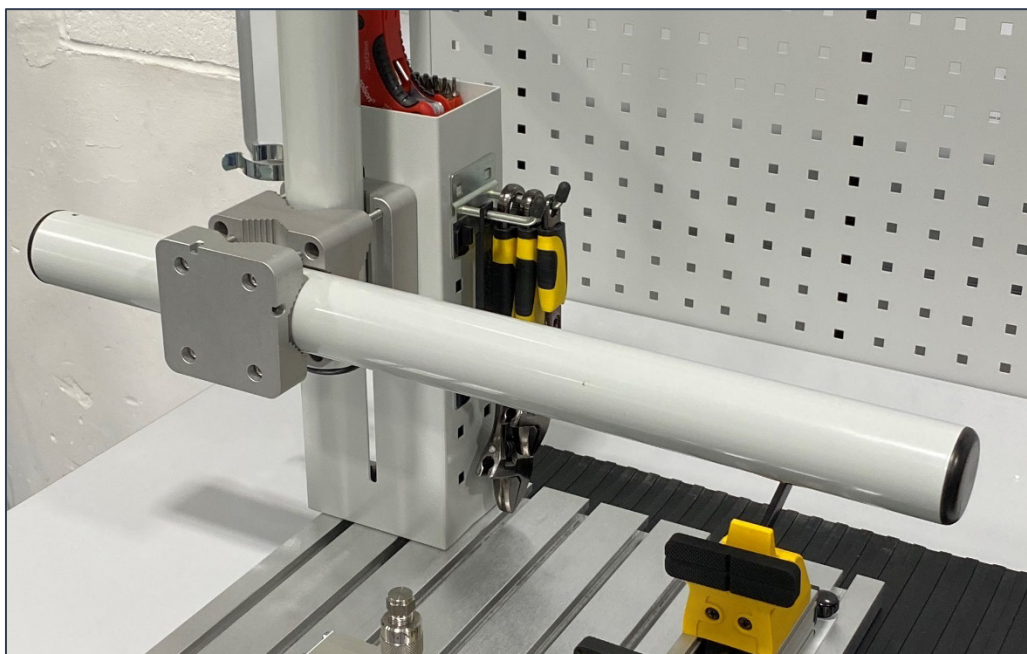
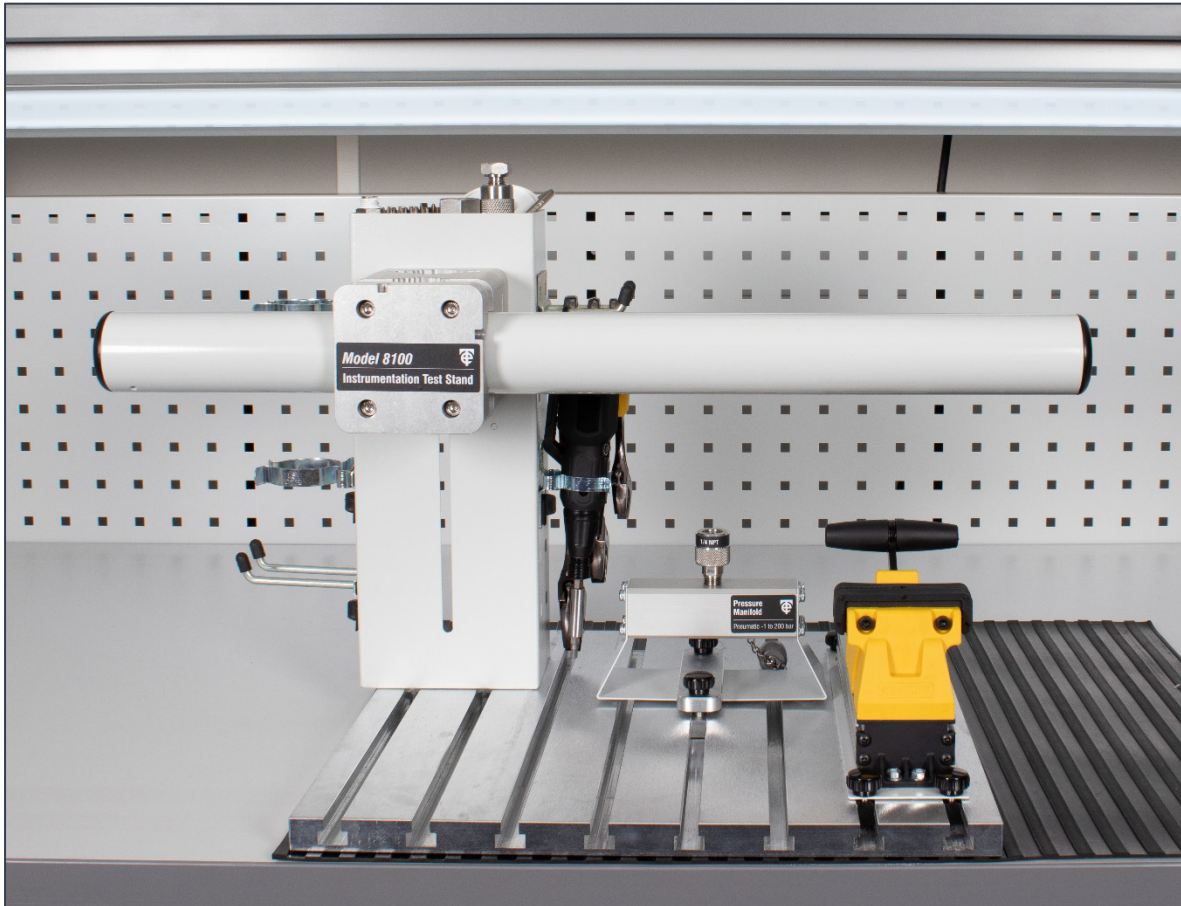

4.3 Support Clamp Configurations

4.3.1 Support Clamp Direct Mounting

Some UUT's can mount directly in the jaws of the support clamp, either front or back section.

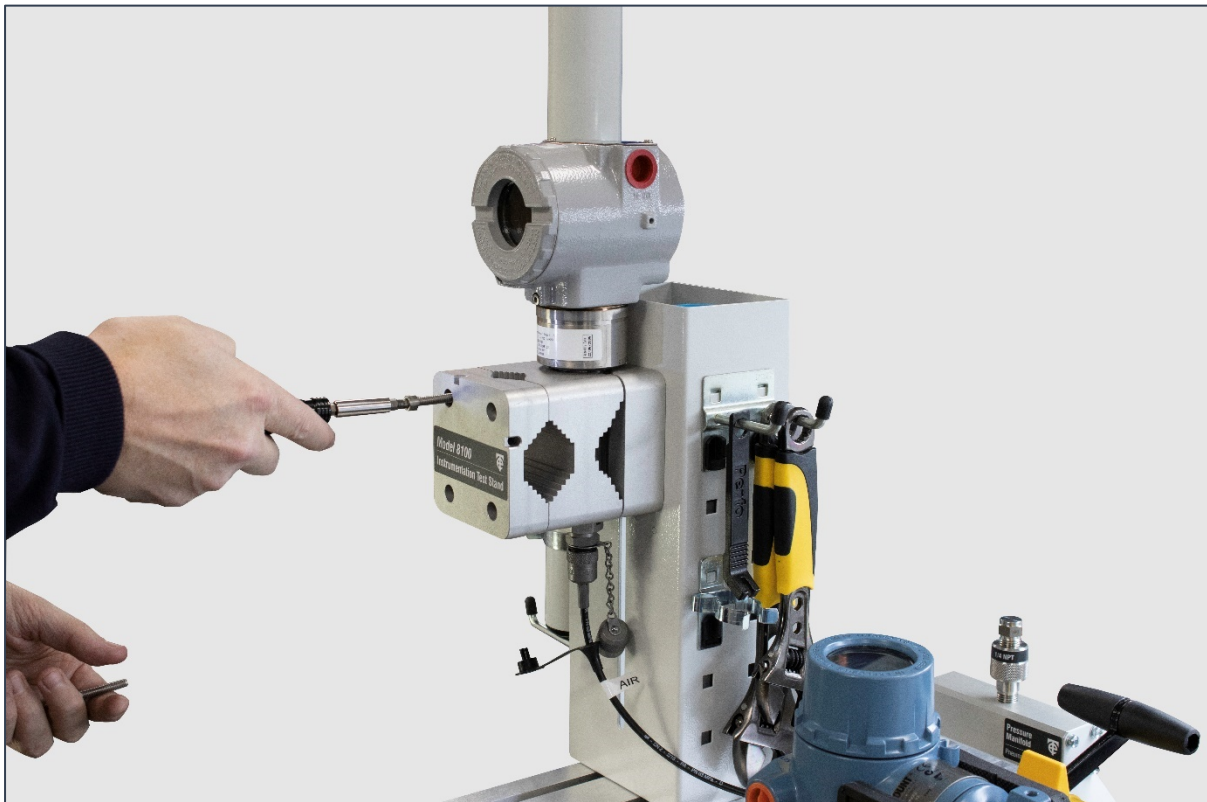

4.3.2 Support Clamp Angle Bracket

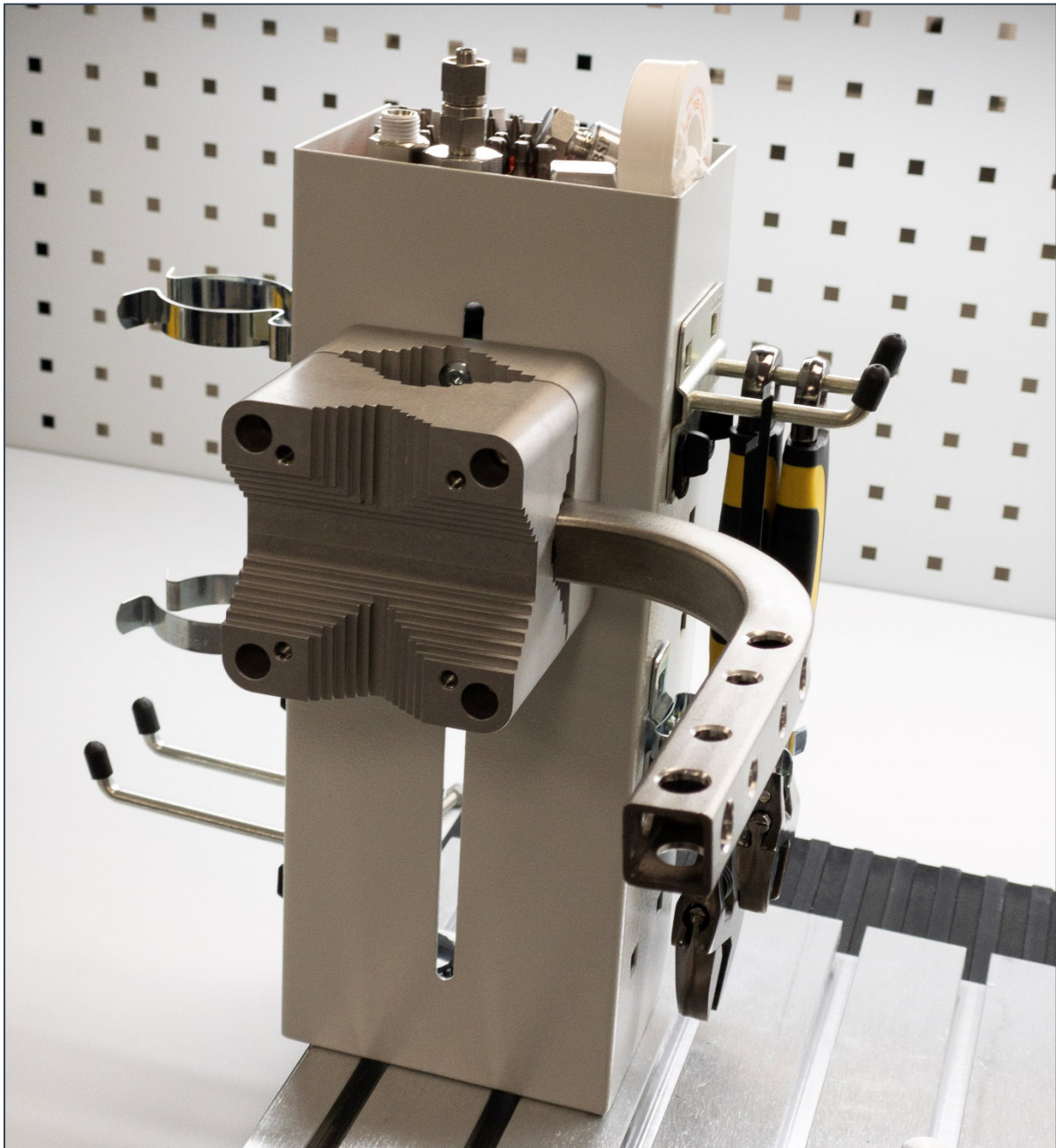

The bracket clamps in the rear jaws as shown.



4.3.3 Support Clamp Multi-Hole Bracket

The multi-hole bracket slots between the rear bolts to make a raising platform.

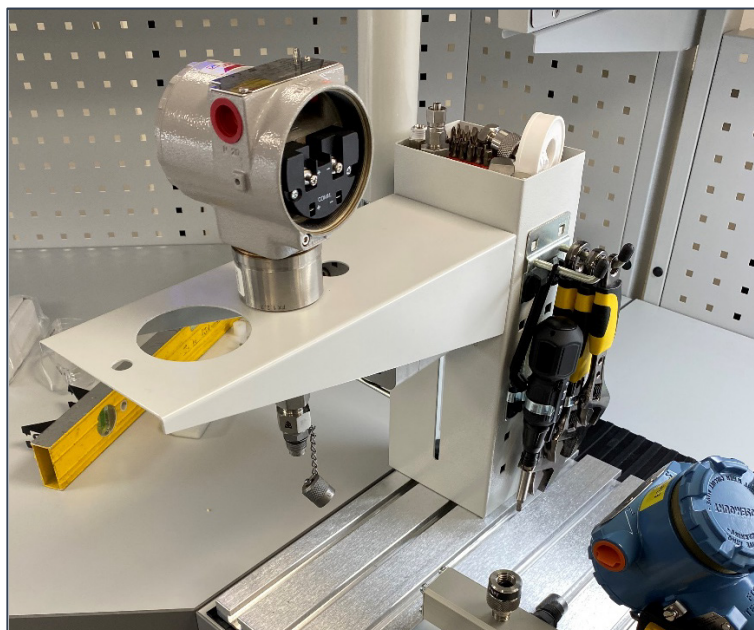
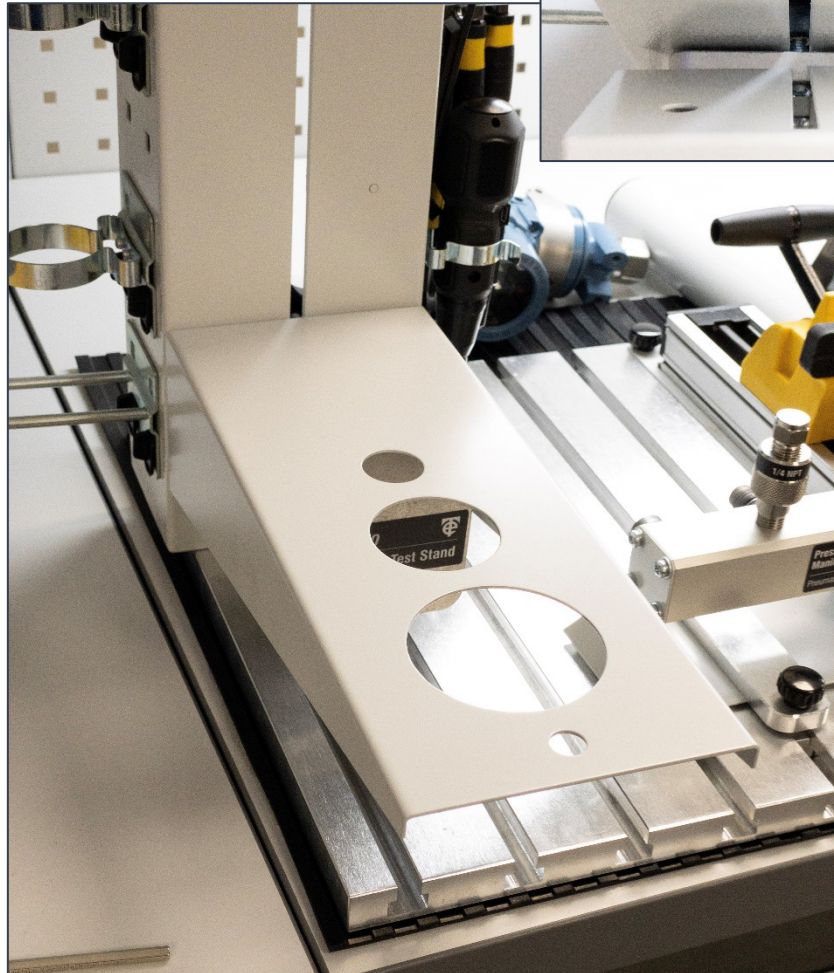

4.3.4 Support Clamp Bolt Mountings

Sometimes a quick method of mounting can be done with the cylinder bolts and the U-clamp, connected to the support clamp. Remove the front and middle section of the support clamp, then use the supplied U-bracket to hold the transmitter.

In the spares box are some 100 mm long cylinder bolts and a u-bolt bracket.

Remove the front and middle sections of the support clamp.

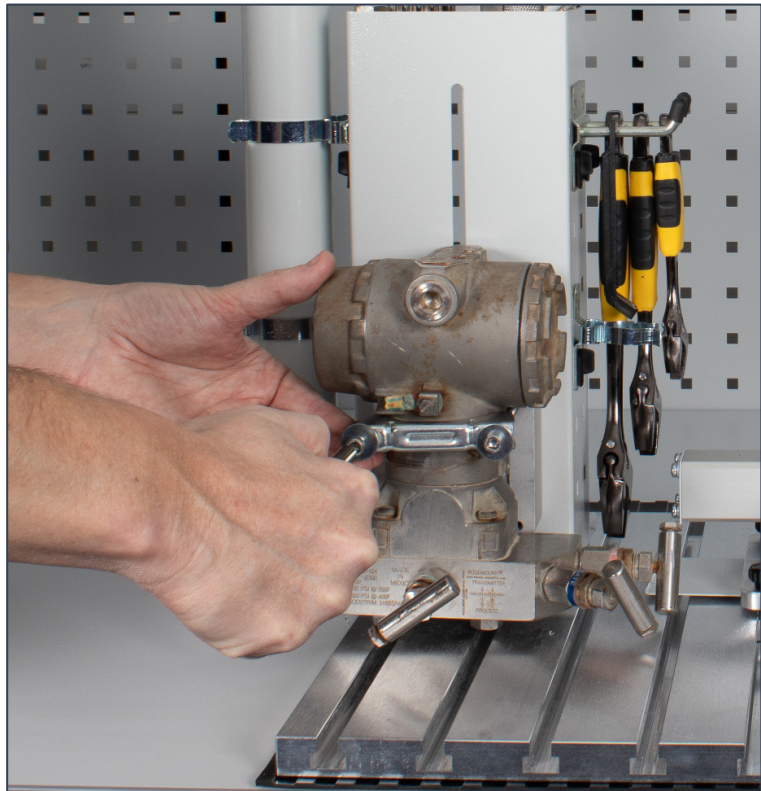
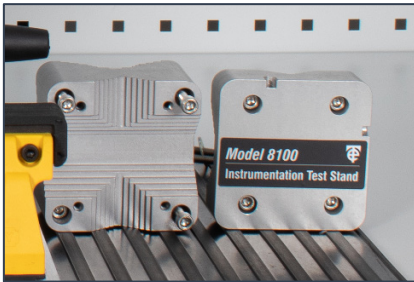

Position the UUT as shown above and screw in the bolts and clamp to hold it in place.

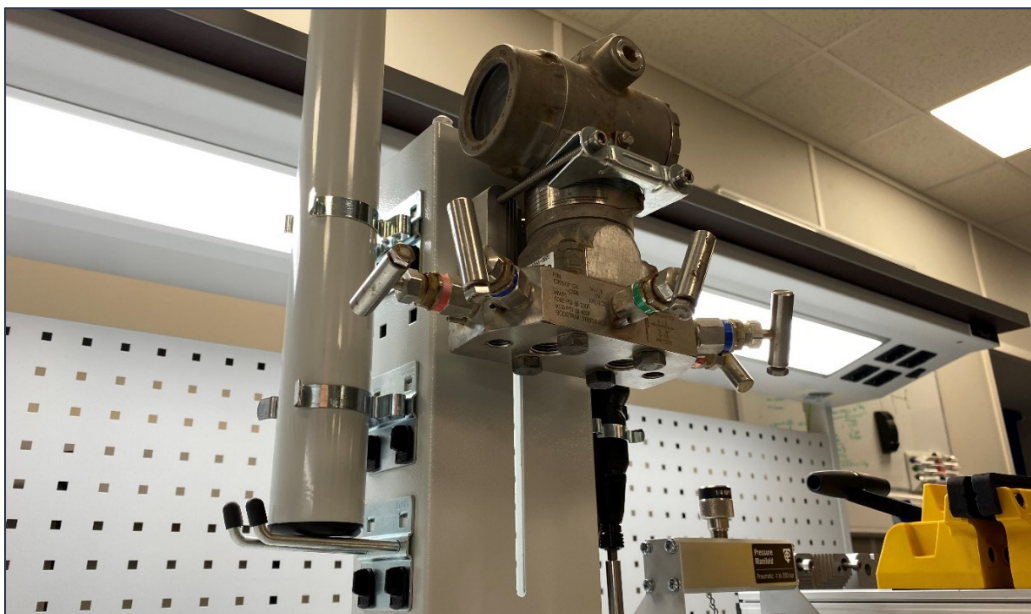

4.3.5 Support Clamp Angle Bracket with Bolts

This mounting is similar to the angle bracket clamp but it utilise the 100 mm cylinder bolts as shown below. These longer bolts pass through the support clamp to hold the angle bracket. It also means the vertical pole can stay in place.



5 Warranty and Servicing

Warranty

The Time Electronics products carry a one-year manufacturer's warranty as standard.

Time Electronics products are designed and manufactured to the highest standards and specifications to assure the quality and performance required by all sectors of industry. Time Electronics products are fully guaranteed against faulty materials and workmanship.

Should this product be found to be defective, please contact us using the below details. Inform us of the product type, serial number, and details of any fault and/or the service required. Please retain the supplier invoice as proof of purchase.

This warranty does not apply to defects resulting from action of the user such as misuse, operation outside of specification, improper maintenance or repair, or unauthorized modification. Time Electronics' total liability is limited to repair or replacement of the product. Note that if Time Electronics determine that the fault on a returned product has been caused by the user, we will contact the customer before proceeding with any repair.

Calibration and Repair Services

Time Electronics offers repair and calibration services for all the products we make and sell. Routine maintenance by the manufacturer ensures optimal performance and condition of the product. Periodic traceable or accredited calibration is available.

Contacting Time Electronics

Online:

Please visit **www.timeelectronics.com** and select Support Request from the Contact links. From this page you will be able to send information to the Time Electronics service team who will help and support you.

By phone:

+44 (0) 1732 355993

By email:

mail@timeelectronics.co.uk

Returning Instruments

Prior to returning your product please contact Time Electronics. We will issue a return merchandise authorization (RMA) number that is to accompany the goods returning. Further instructions will also be issued prior to shipment. When returning instruments, please ensure that they have been adequately packed, preferably in the original packing supplied. **Time Electronics Ltd will not accept responsibility for units returned damaged.** Please ensure that all units have details of the service required and all relevant paperwork.

Send the instrument, shipping charges paid to:

Time Electronics Ltd

Unit 5, TON Business Park, 2-8 Morley Road,
Tonbridge, Kent, TN9 1RA.
United Kingdom.

Tel: +44(0)1732 355993

Fax: +44(0)1732 350198

Email: mail@timeelectronics.co.uk

Web Site: www.timeelectronics.com

Disposal of your old equipment

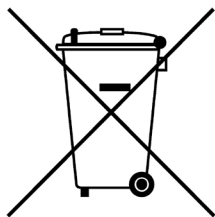

1. When this crossed-out wheeled bin symbol is attached to a product it means the product is covered by the European Directive 2002/96/EC.
2. All electrical and electronic products should be disposed of separately from the municipal waste stream via designated collection facilities appointed by the government or the local authorities.
3. The correct disposal of your old appliance will help prevent potential negative consequences for the environment and human health.
4. For more detailed information about disposal of your old appliance, please contact your city office, waste disposal service or return to Time Electronics.